

Cast Iron Radiator

BGL-760

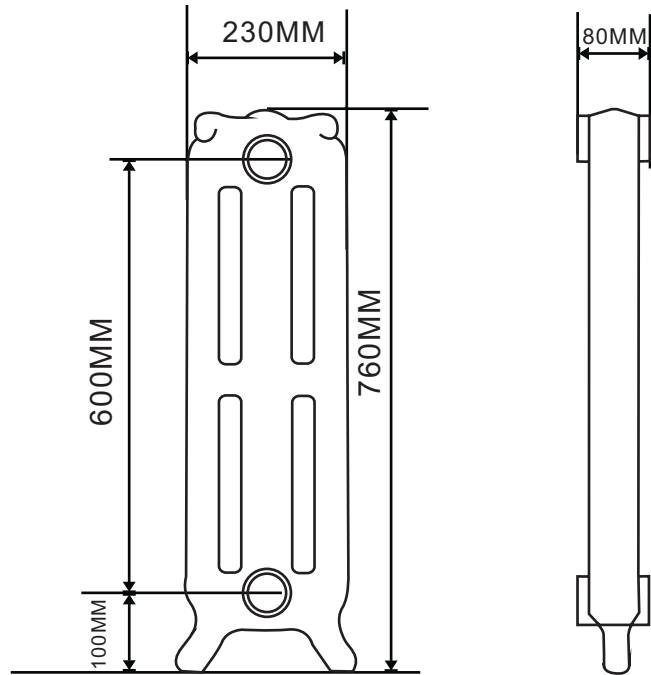

Specification	Weight	Delta 50	Delta 60
sections	kgs	watts	watts
3	39	405	480
4	52	540	640
5	65	675	800
6	78	810	960
7	91	945	1120
8	104	1080	1280
9	117	1215	1440
10	130	1350	1600
11	143	1485	1760
12	156	1620	1920
13	169	1755	2080
14	182	1890	2240
15	195	2025	2400